

**HEXFET® Power MOSFET for DC-DC Converters**

- N-Channel Application-Specific MOSFETs
- Ideal for CPU Core DC-DC Converters
- Low Conduction Losses
- Low Switching Losses
- 100% Tested for  $R_G$

**Description**

This new device employs advanced HEXFET Power MOSFET technology to achieve an unprecedented balance of on-resistance and gate charge. The reduced conduction and switching losses make it ideal for high efficiency DC-DC converters that power the latest generation of microprocessors.

The IRF7811W has been optimized for all parameters that are critical in synchronous buck converters including  $R_{DS(on)}$ , gate charge and  $Cdv/dt$ -induced turn-on immunity. The IRF7811W offers particularly low  $R_{DS(on)}$  and high  $Cdv/dt$  immunity for synchronous FET applications.

The package is designed for vapor phase, infra-red, convection, or wave soldering techniques. Power dissipation of greater than 3W is possible in a typical PCB mount application.

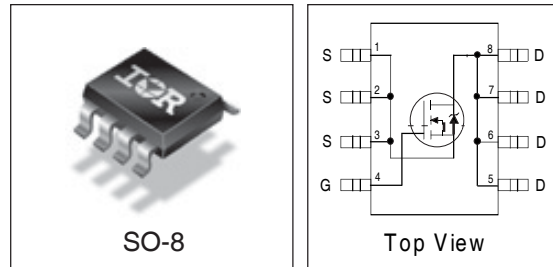

**DEVICE CHARACTERISTICS<sup>⑤</sup>**

	<b>IRF7811W</b>
$R_{DS(on)}$	9.0mΩ
$Q_G$	22nC
$Q_{sw}$	10.1nC
$Q_{oss}$	12nC

**Absolute Maximum Ratings**

Parameter	Symbol	IRF7811W	Units
Drain-Source Voltage	$V_{DS}$	30	V
Gate-Source Voltage	$V_{GS}$	±12	
Continuous Drain or Source Current ( $V_{GS} \geq 4.5V$ )	$I_D$	$T_A = 25^\circ C$	14
		$T_L = 90^\circ C$	13
Pulsed Drain Current <sup>①</sup>	$I_{DM}$	109	A
Power Dissipation	$P_D$	$T_A = 25^\circ C$	3.1
		$T_L = 90^\circ C$	3.0
Junction & Storage Temperature Range	$T_J, T_{STG}$	-55 to 150	°C
Continuous Source Current (Body Diode)	$I_S$	3.8	A
Pulsed Source Current <sup>①</sup>	$I_{SM}$	109	

**Thermal Resistance**

Parameter		Max.	Units
Maximum Junction-to-Ambient <sup>③</sup>	$R_{\theta JA}$	40	°C/W
Maximum Junction-to-Lead	$R_{\theta JL}$	20	°C/W

# IRF7811W

International  
IR Rectifier

## Electrical Characteristics

Parameter		Min	Typ	Max	Units	Conditions
Drain-to-Source Breakdown Voltage	$BV_{DSS}$	30	-	-	V	$V_{GS} = 0V, I_D = 250\mu A$
Static Drain-Source on Resistance	$R_{DS(on)}$		9.0	12	m $\Omega$	$V_{GS} = 4.5V, I_D = 15A$ ②
Gate Threshold Voltage	$V_{GS(th)}$	1.0			V	$V_{DS} = V_{GS}, I_D = 250\mu A$
Drain-Source Leakage Current	$I_{DSS}$			30	$\mu A$	$V_{DS} = 24V, V_{GS} = 0$
				150		$V_{DS} = 24V, V_{GS} = 0,$ $T_j = 100^\circ C$
Gate-Source Leakage Current	$I_{GSS}$			$\pm 100$	nA	$V_{GS} = \pm 12V$
Total Gate Chg Cont FET	$Q_G$		22	33	nC	$V_{GS}=5.0V, I_D=15A, V_{DS}=16V$
Total Gate Chg Sync FET	$Q_G$		16.3			$V_{GS} = 5V, V_{DS} < 100mV$
Pre-Vth Gate-Source Charge	$Q_{GS1}$		3.5			$V_{DS} = 16V, I_D = 15A, V_{GS} = 5.0V$
Post-Vth Gate-Source Charge	$Q_{GS2}$		1.2			
Gate to Drain Charge	$Q_{GD}$		8.8			
Switch Chg( $Q_{GS2} + Q_{GD}$ )	$Q_{sw}$		10.1			
Output Charge	$Q_{OSS}$		12			$V_{DS} = 16V, V_{GS} = 0$
Gate Resistance	$R_G$		2.0	4.0	$\Omega$	
Turn-on Delay Time	$t_{d(on)}$		11		ns	$V_{DD} = 16V, I_D = 15A$
Rise Time	$t_r$		11			$V_{GS} = 5.0V$
Turn-off Delay Time	$t_{d(off)}$		29			Clamped Inductive Load
Fall Time	$t_f$		9.9			
Input Capacitance	$C_{ISS}$	-	2335	-	pF	$V_{DS} = 16V, V_{GS} = 0$
Output Capacitance	$C_{OSS}$	-	400	-		
Reverse Transfer Capacitance	$C_{RSS}$	-	119	-		

## Source-Drain Rating & Characteristics

Parameter		Min	Typ	Max	Units	Conditions
Diode Forward Voltage*	$V_{SD}$			1.25	V	$I_S = 15A$ ②, $V_{GS} = 0V$
Reverse Recovery Charge④	$Q_{rr}$		45		nC	$di/dt \sim 700A/\mu s$ $V_{DS} = 16V, V_{GS} = 0V, I_S = 15A$
Reverse Recovery Charge (with Parallel Schottky)④	$Q_{rr(s)}$		41		nC	$di/dt = 700A/\mu s$ (with 10BQ040) $V_{DS} = 16V, V_{GS} = 0V, I_S = 15A$

- Notes:**
- ① Repetitive rating; pulse width limited by max. junction temperature.
  - ② Pulse width  $\leq 400 \mu s$ ; duty cycle  $\leq 2\%$ .
  - ③ When mounted on 1 inch square copper board
  - ④ Typ = measured -  $Q_{OSS}$
  - ⑤ Typical values of  $R_{DS(on)}$  measured at  $V_{GS} = 4.5V$ ,  $Q_G$ ,  $Q_{sw}$  and  $Q_{OSS}$  measured at  $V_{GS} = 5.0V, I_F = 15A$ .

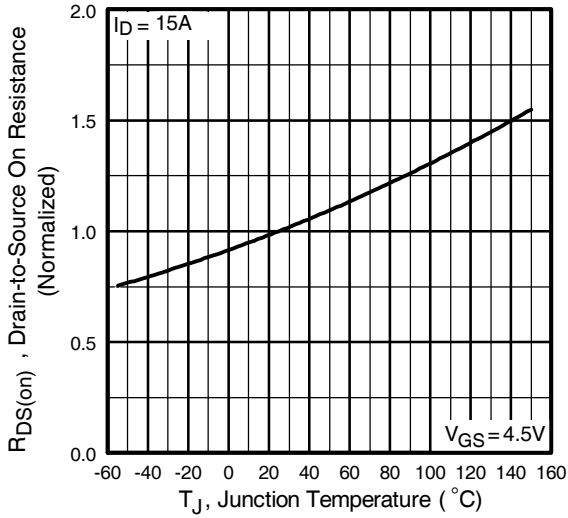

**Fig 1.** Normalized On-Resistance Vs. Temperature

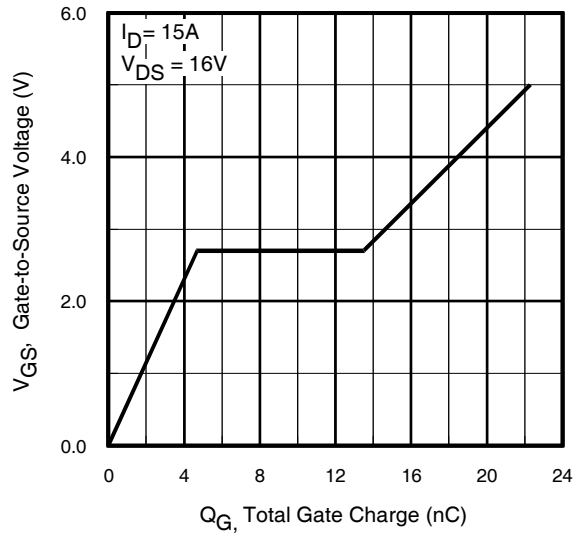

**Fig 2.** Typical Gate Charge Vs. Gate-to-Source Voltage

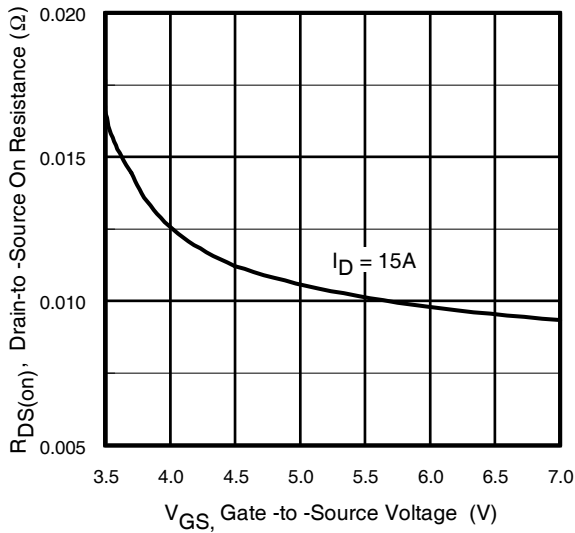

**Fig 3.** On-Resistance Vs. Gate Voltage

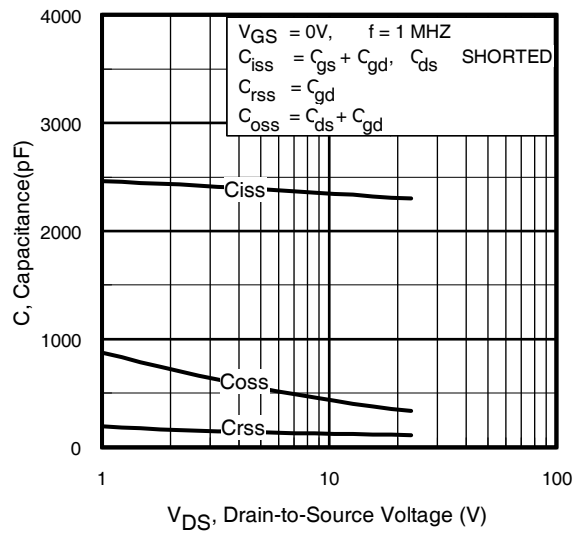

**Fig 4.** Typical Capacitance Vs. Drain-to-Source Voltage

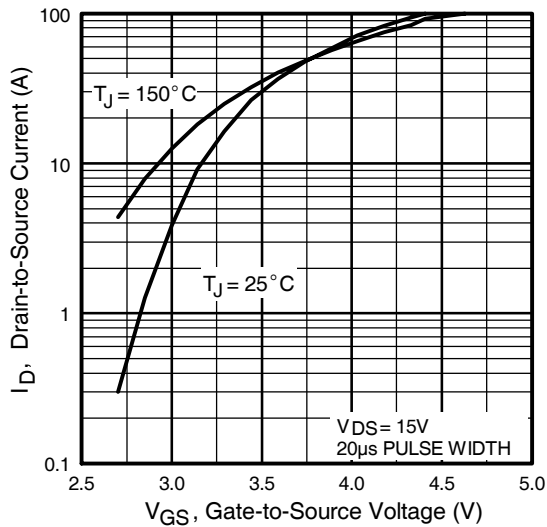

**Fig 5.** Typical Transfer Characteristics

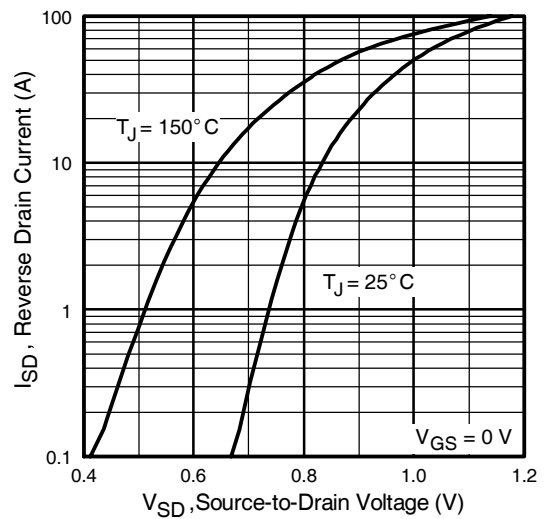

**Fig 6.** Typical Source-Drain Diode Forward Voltage

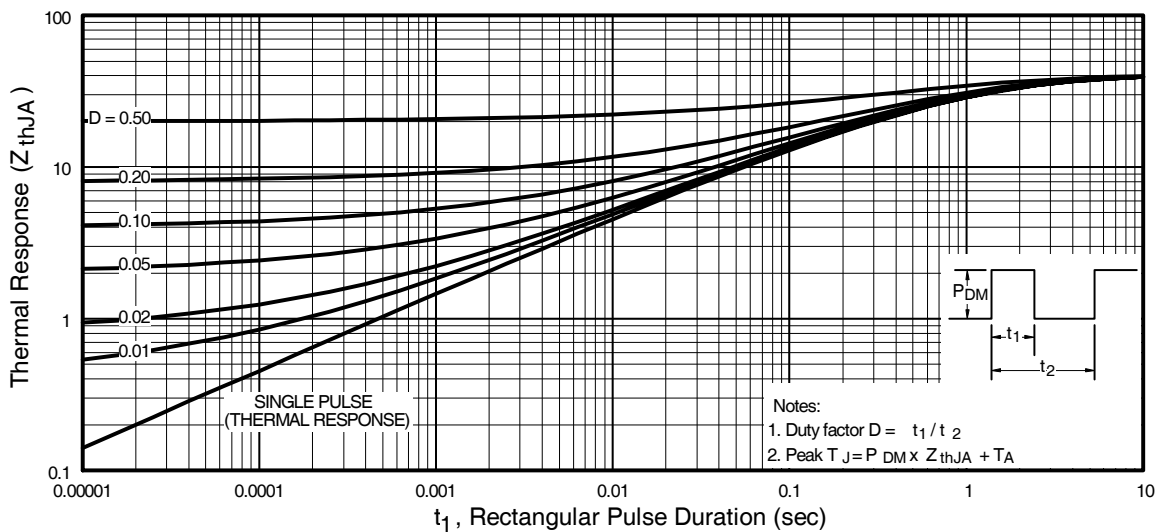

**Figure 7.** Maximum Effective Transient Thermal Impedance, Junction-to-Ambient

## SO-8 Package Outline (MOSFET & Fetky)

Dimensions are shown in millimeters (inches)

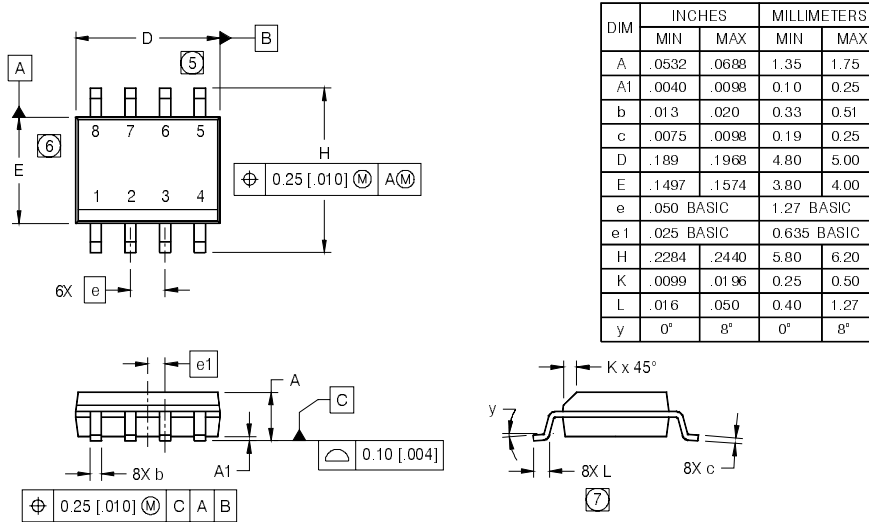

- NOTES:
1. DIMENSIONING & TOLERANCING PER ASME Y14.5M-1994.
  2. CONTROLLING DIMENSION: MILLIMETER
  3. DIMENSIONS ARE SHOWN IN MILLIMETERS (INCHES).
  4. OUTLINE CONFORMS TO JEDEC OUTLINE MS-012AA.
  5. DIMENSION DOES NOT INCLUDE MOLD PROTRUSIONS. MOLD PROTRUSIONS NOT TO EXCEED 0.15 [ .006].
  6. DIMENSION DOES NOT INCLUDE MOLD PROTRUSIONS. MOLD PROTRUSIONS NOT TO EXCEED 0.25 [ .010].
  7. DIMENSION IS THE LENGTH OF LEAD FOR SOLDERING TO A SUBSTRATE.

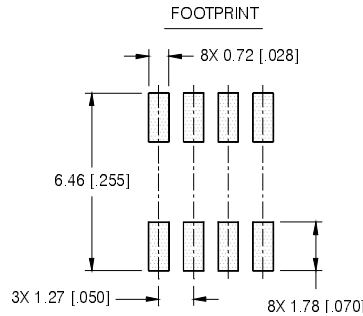

## SO-8 Part Marking Information

EXAMPLE: THIS IS AN IRF7101 (MOSFET)

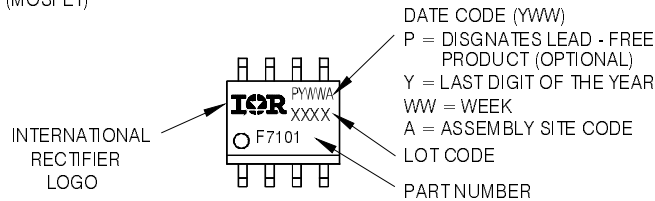

Note: For the most current drawing please refer to IR website at: <http://www.irf.com/package/>

# IRF7811W

International  
**IR** Rectifier

## SO-8 Tape and Reel

Dimensions are shown in millimeters (inches)

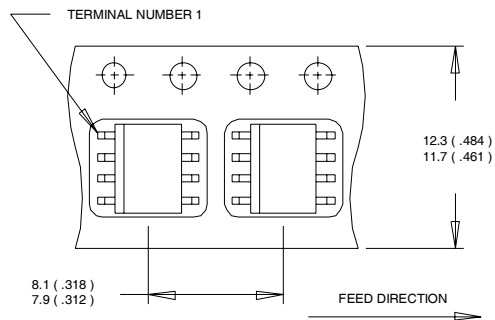

**NOTES:**

1. CONTROLLING DIMENSION : MILLIMETER.
2. ALL DIMENSIONS ARE SHOWN IN MILLIMETERS(INCHES).
3. OUTLINE CONFORMS TO EIA-481 & EIA-541.

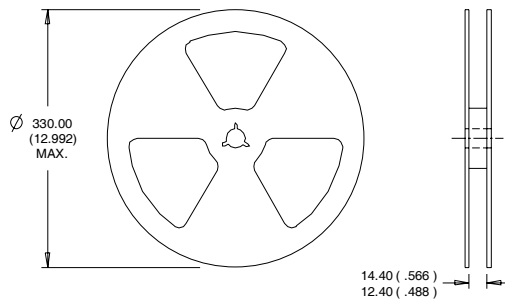

**NOTES :**

1. CONTROLLING DIMENSION : MILLIMETER.
2. OUTLINE CONFORMS TO EIA-481 & EIA-541.

**Note:** For the most current drawing please refer to IR website at: <http://www.irf.com/package/>

Data and specifications subject to change without notice.  
This product has been designed and qualified for the Consumer market.  
Qualification Standards can be found on IR's Web site.

International  
**IR** Rectifier

**IR WORLD HEADQUARTERS:** 233 Kansas St., El Segundo, California 90245, USA Tel: (310) 252-7105  
TAC Fax: (310) 252-7903

Visit us at [www.irf.com](http://www.irf.com) for sales contact information. 07/2008